

begane grond

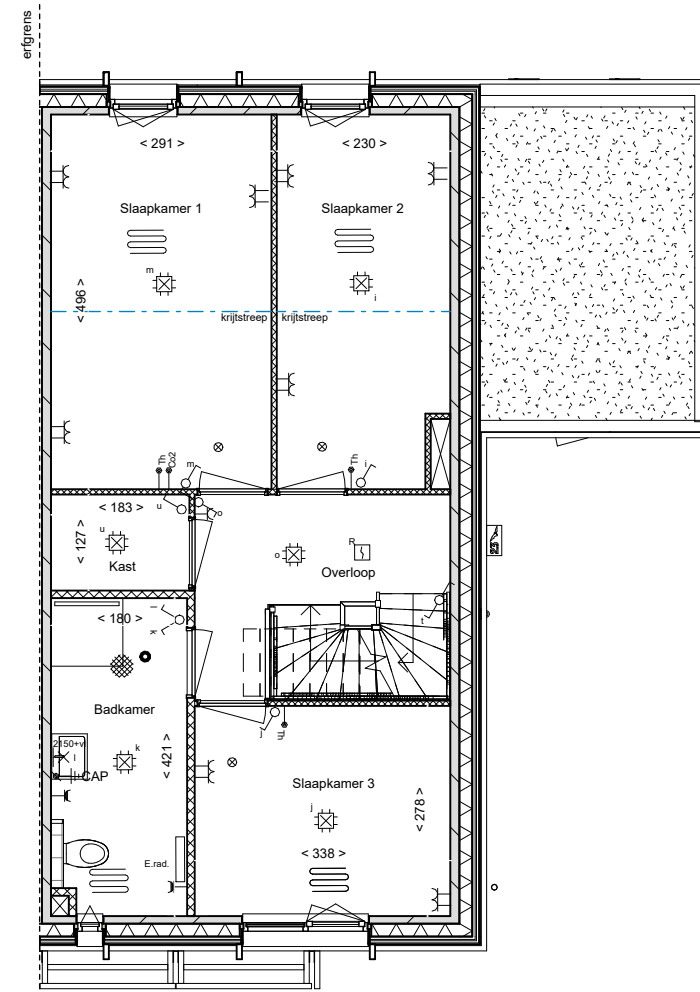

eerste verdieping

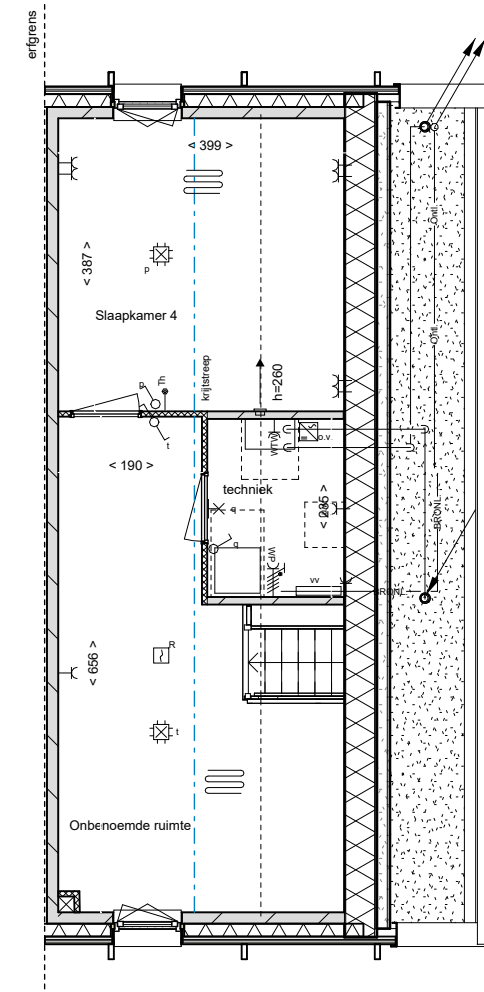

zolder

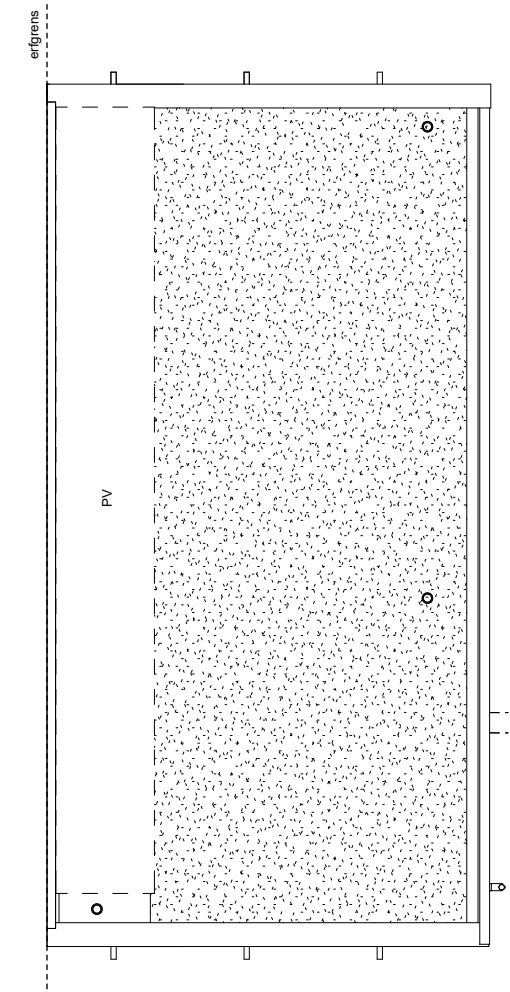

dakaanzicht

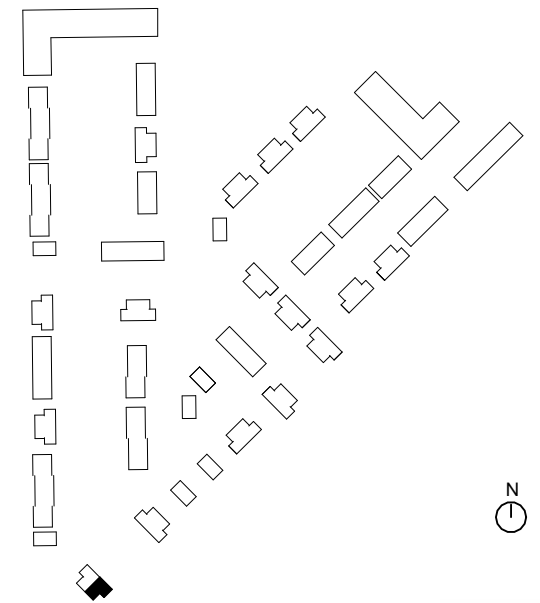

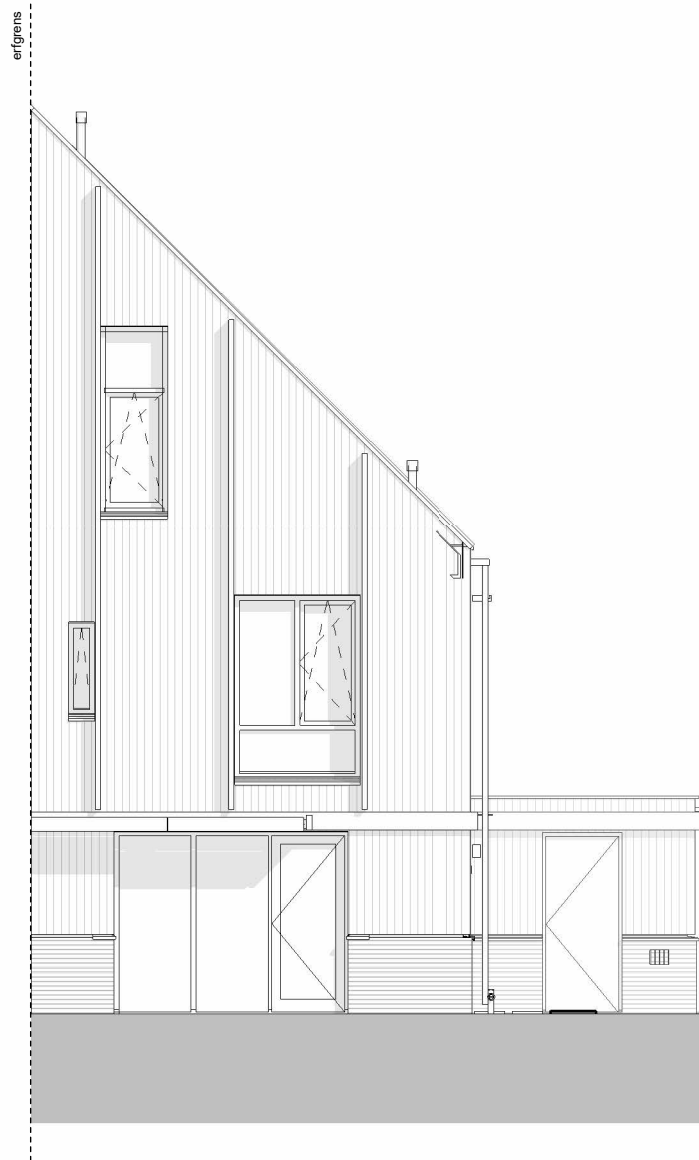

voorgevel (zuidwest)

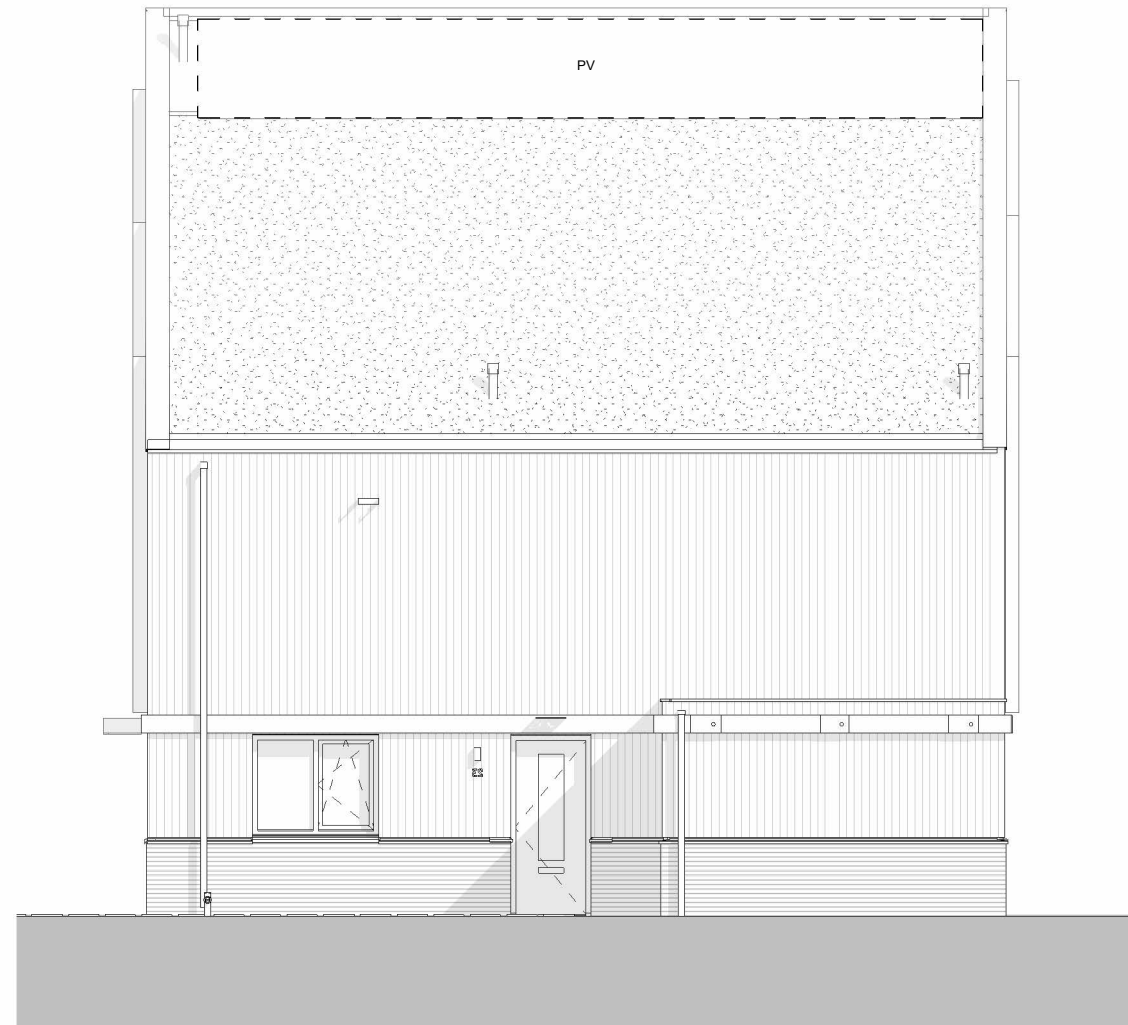

zijgevel (zuidoost)

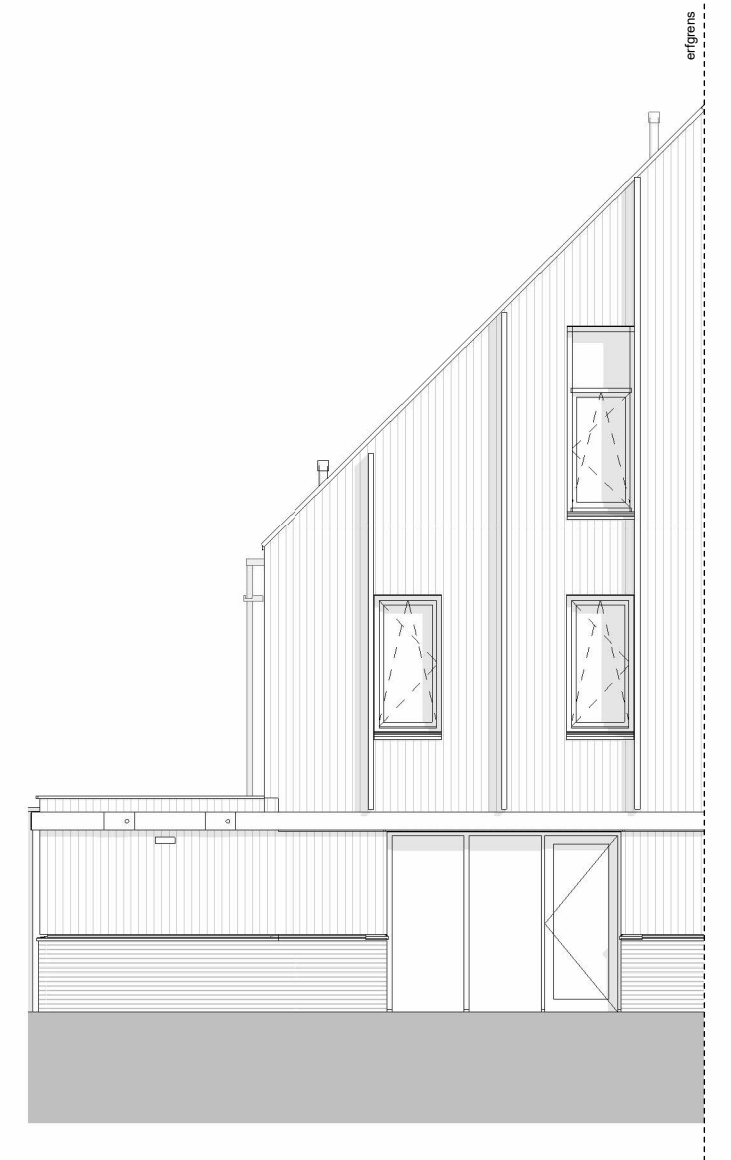

achtergevel (noordoost)

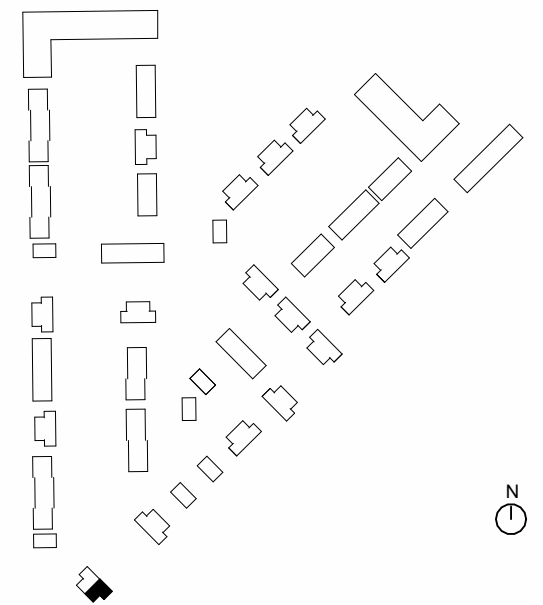

Omschrijving
Gevelaanzichten

Onderdeel Verkooptekening	tekeningnummer VK-016-2	getekend 24-09-2024	schaal 1 : 100	formaat A3
Bouwnummer(s) 16 (2K)				

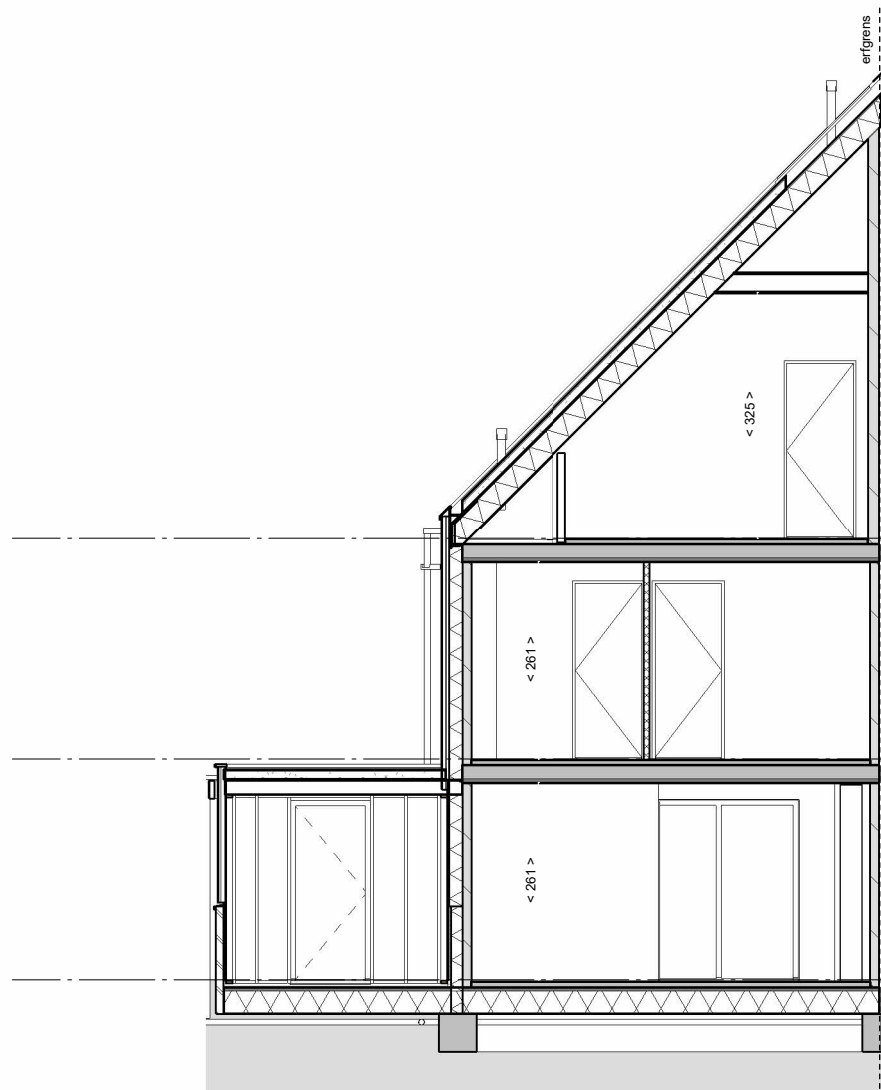

langsdoorsnede

02 tweede verdieping
+5840

01 eerste verdieping
+2920

00 begane grond
+0

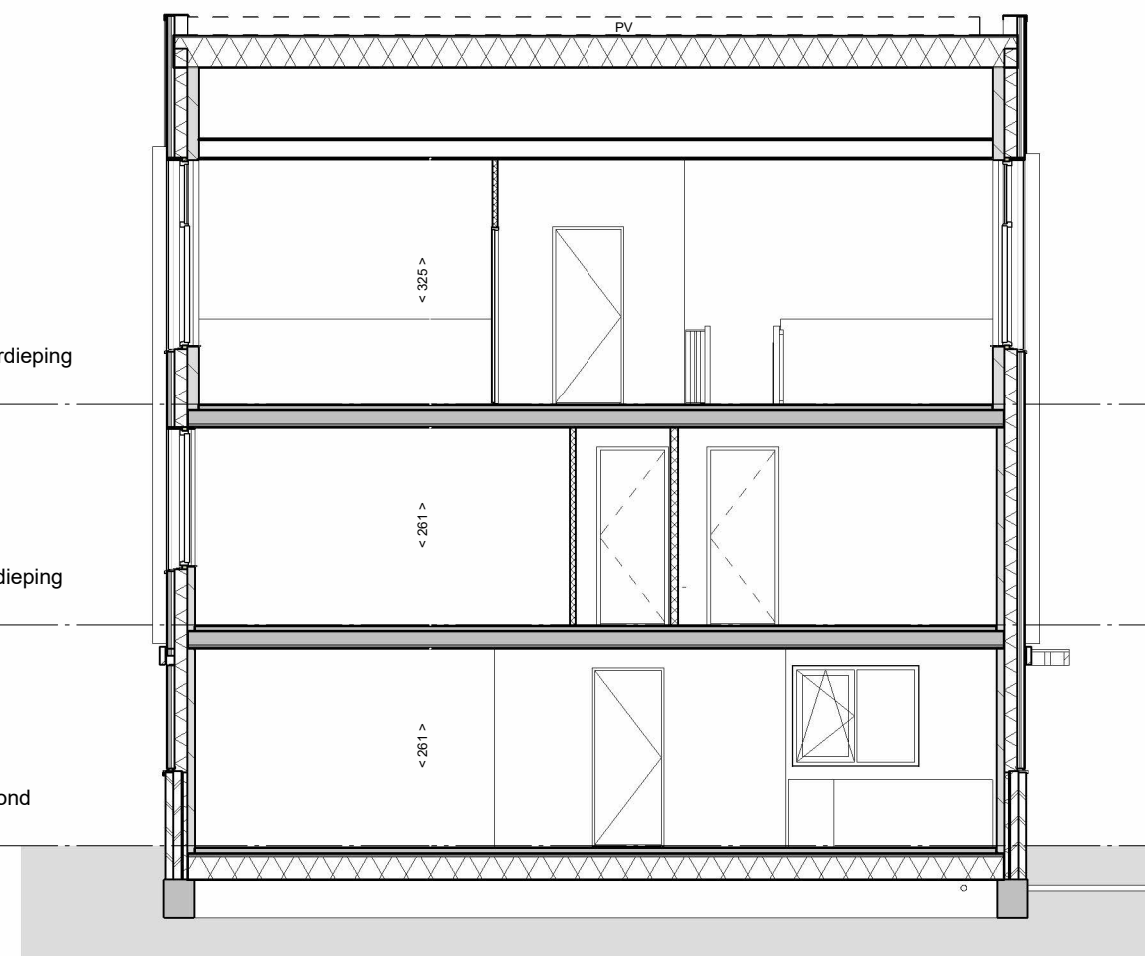

dwarsdoorsnede

02 tweede verdieping
+5840

01 eerste verdieping
+2920

00 begane grond
+0

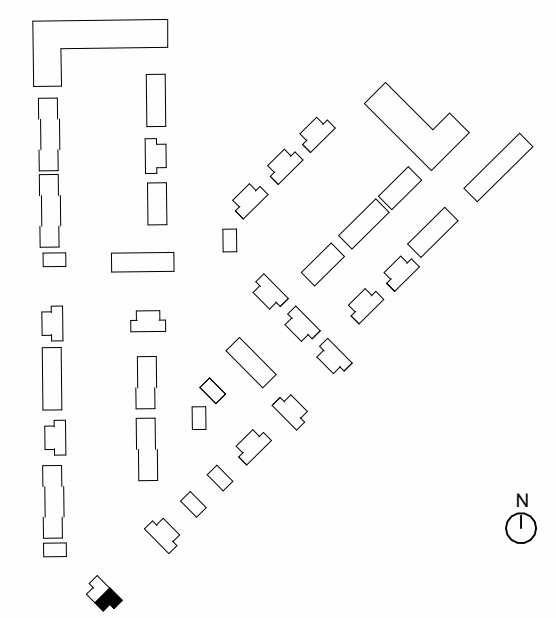

Omschrijving
Doorsnedes

Onderdeel Verkooptekening	tekeningnummer VK-016-3	getekend 24-09-2024	schaal 1 : 100	formaat A3
Bouwnummer(s) 16 (2K)				

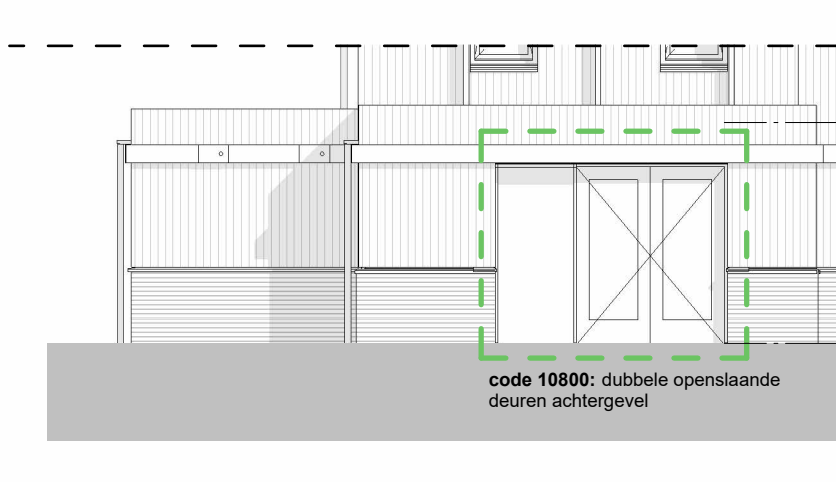

code 10140: uitbouw achtergevel 120cm

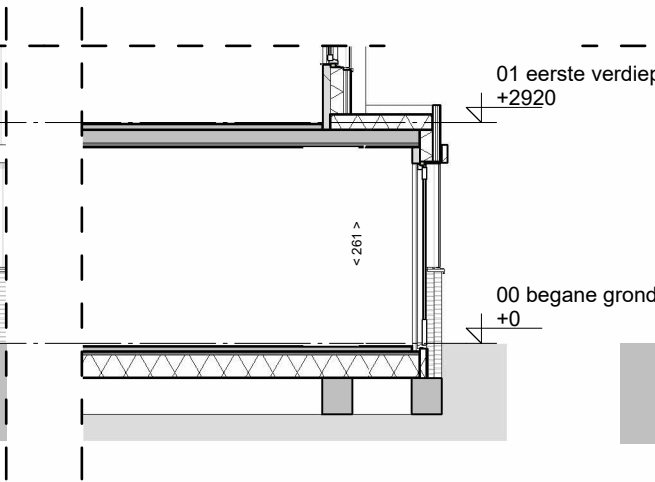

code 10140 / 50: uitbouw achtergevel 120cm

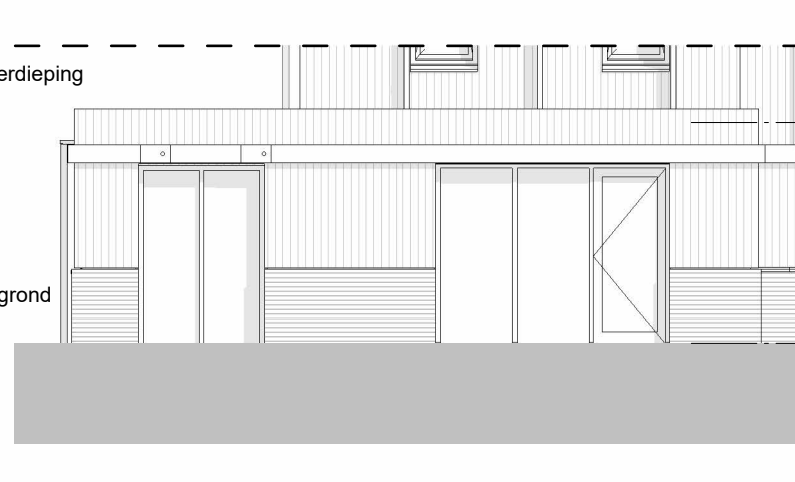

code 10150: uitbouw achtergevel en berging 120cm

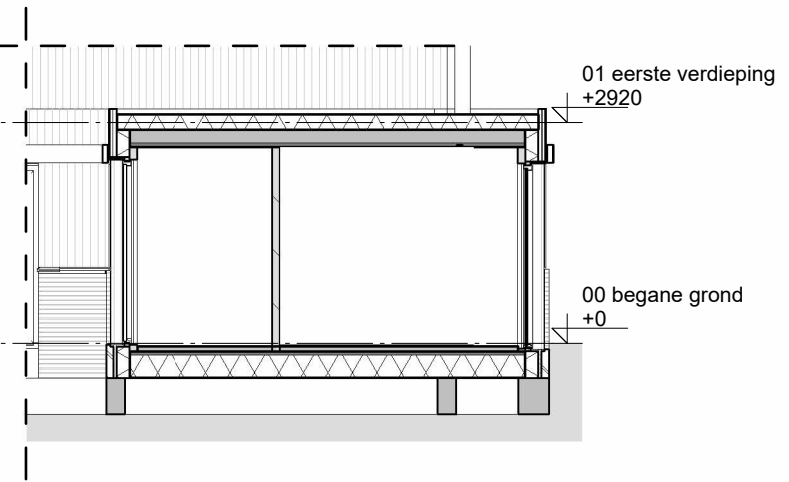

code 10120: uitbouw achtergevel en berging 120cm

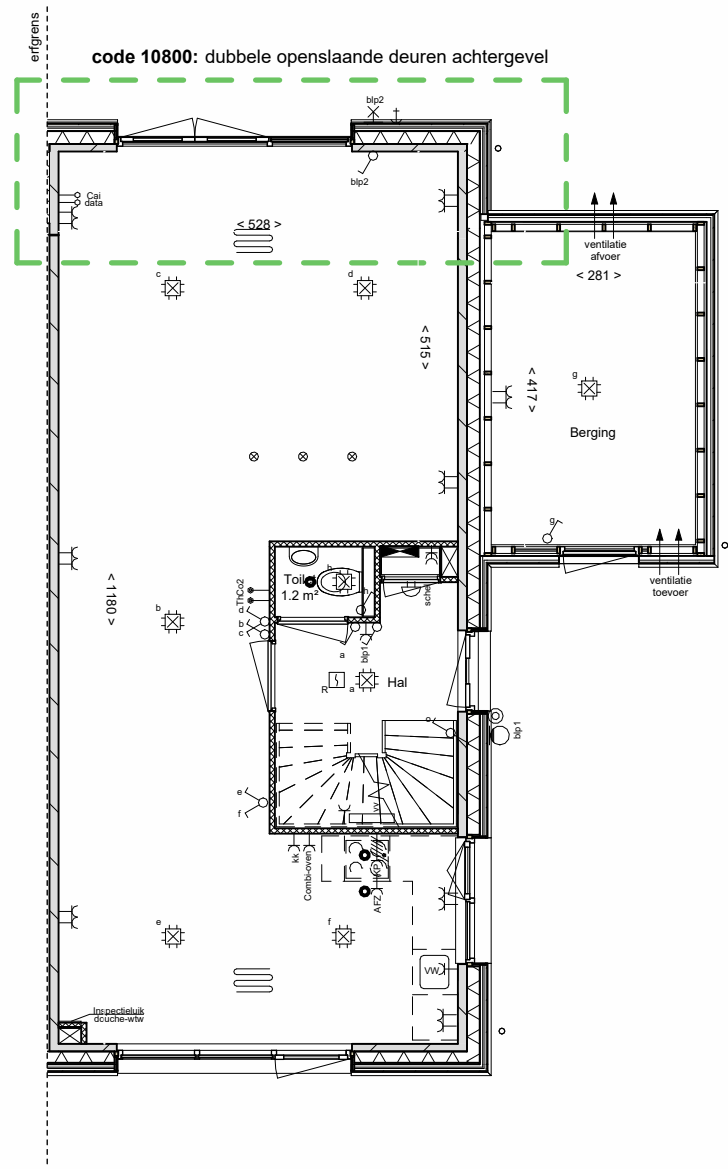

begane grond

code 10140: uitbouw achtergevel 120cm

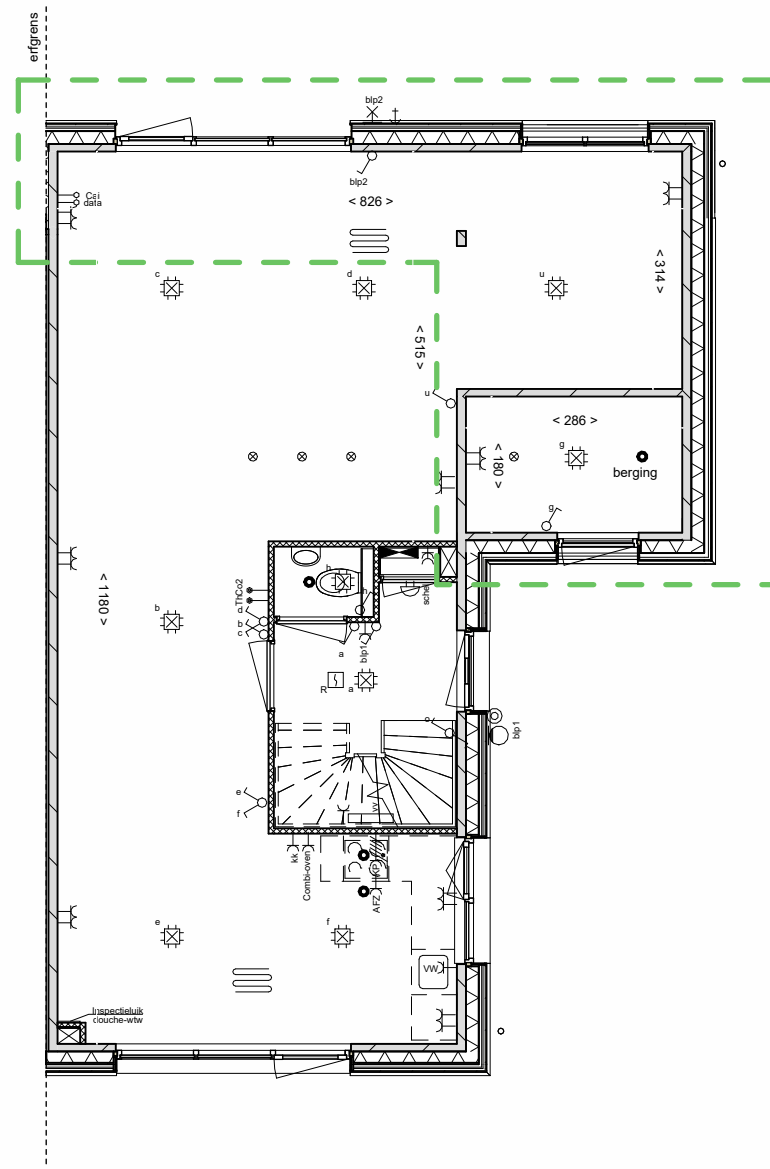

begane grond

code 10150: uitbouw achtergevel en berging 120cm

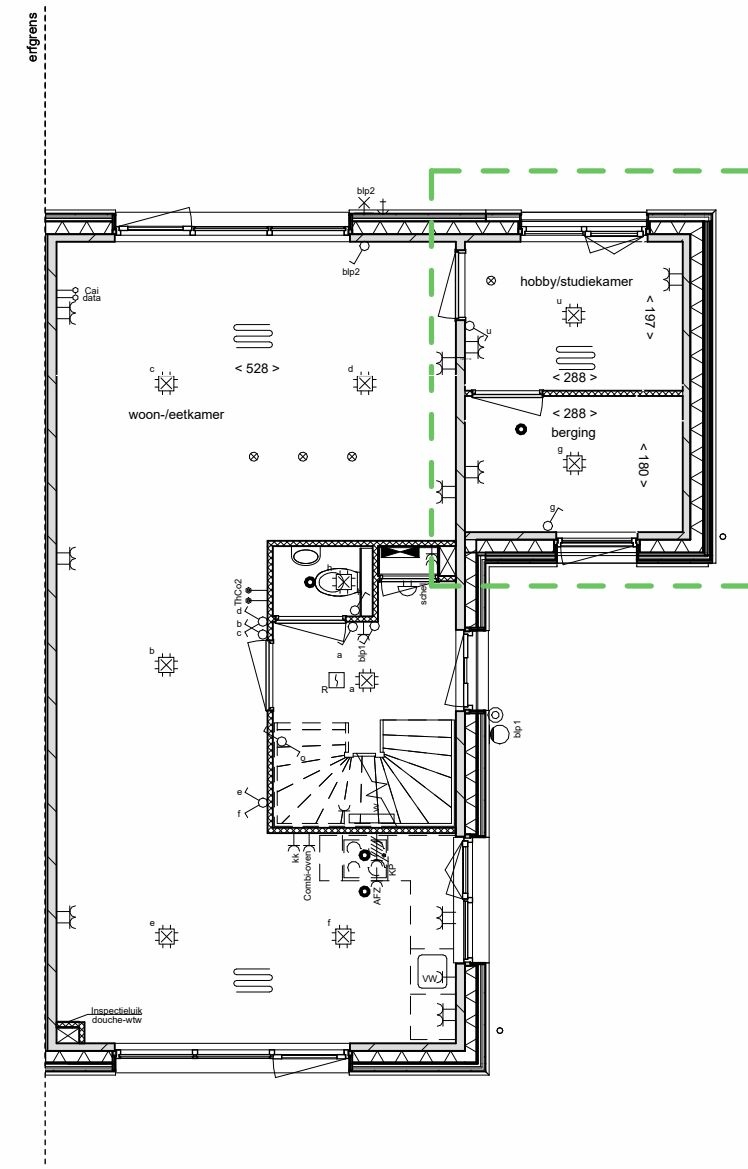

begane grond

code 12010: splitsing berging

NB:
Kopersopties slechts ter indicatie van de extra ruimte en bijbehorende gevelopeningen; materialisatie van de gevel (hout of metselwerk) wijkt mogelijk af van uw bouwnummer.

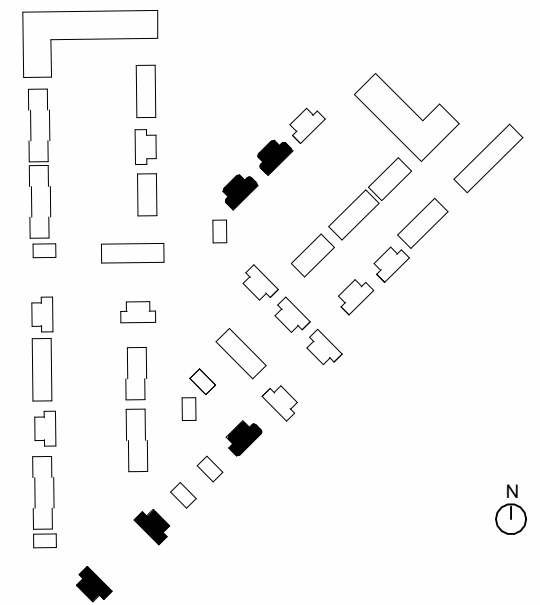

Omschrijving
Optietekening

Onderdeel	tekeningnummer		
Verkooptekening	VK-014-4		
Bouwnummer(s)	getekend	schaal	formaat
10-11,14-17,105-108	24-09-2024	1 : 100	A3

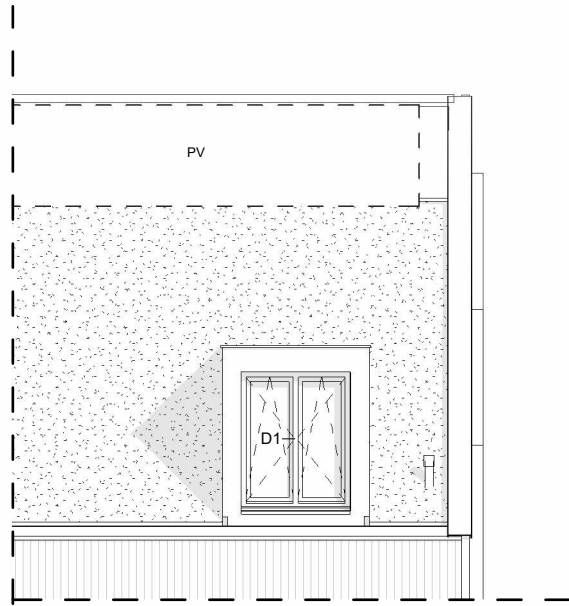

code 10510: dakkapel

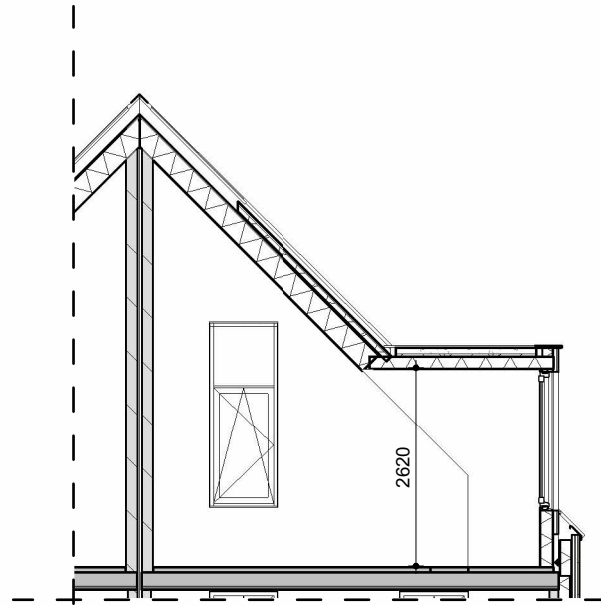

code 10510: dakkapel

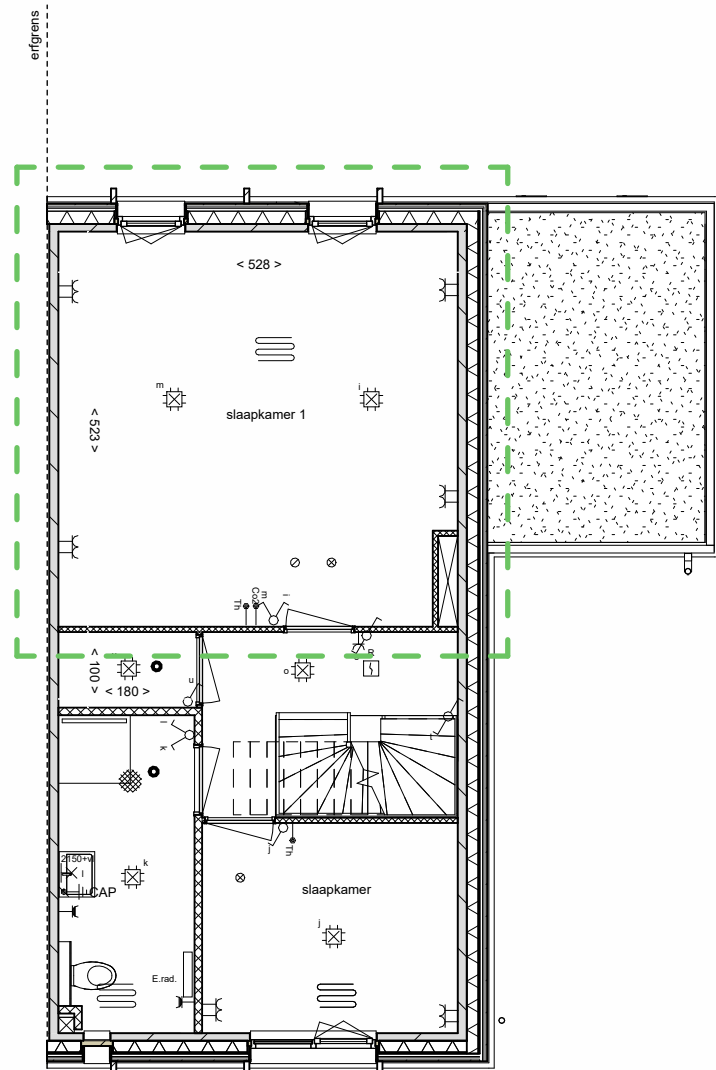

eerste verdieping

code 12145: samengevoegde slaapkamers

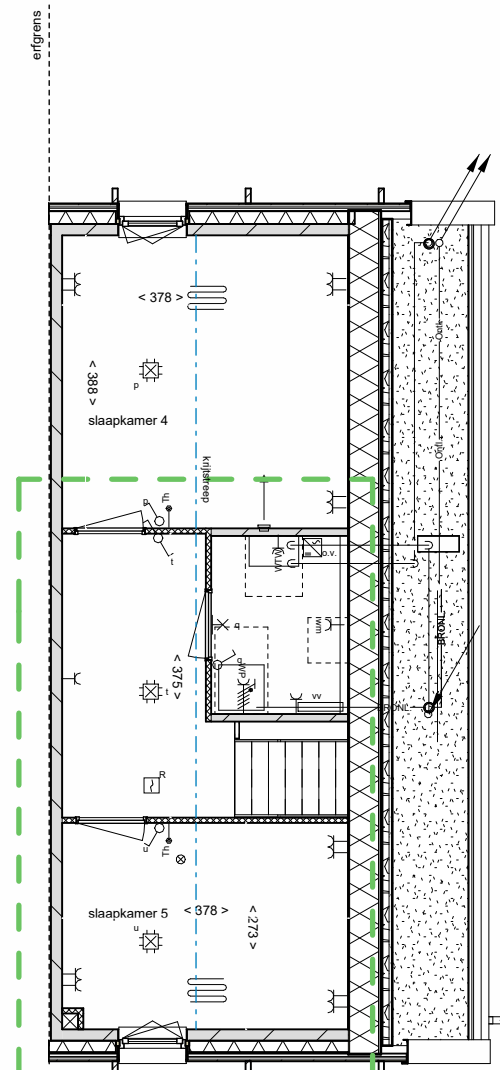

zolder

code 12410: splitsing zolder

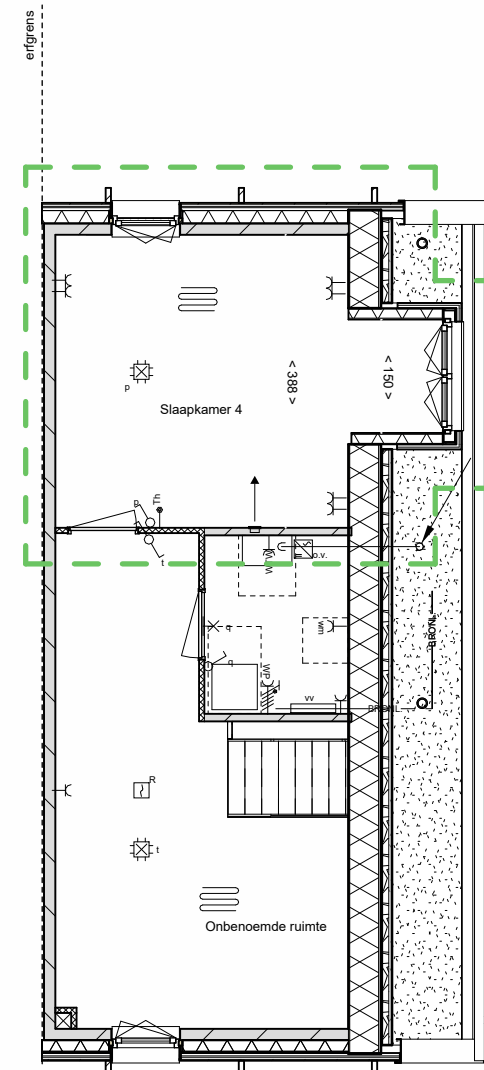

zolder

code 10510: dakkapel

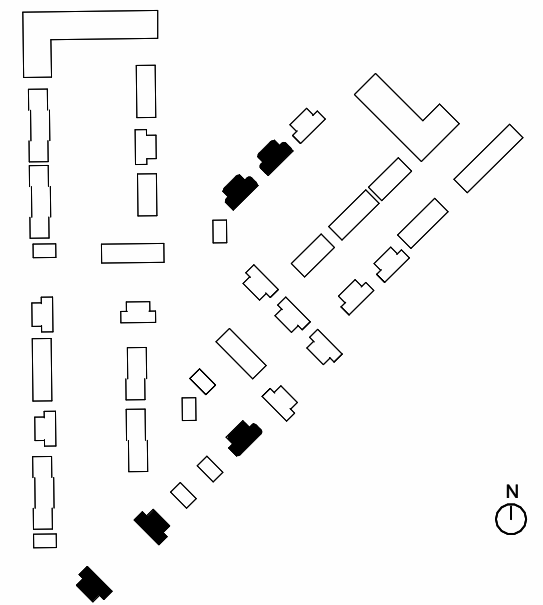

NB:
Kopersopties slechts ter indicatie van de extra ruimte en bijbehorende gevelopeningen; materialisatie van de gevel (hout of metselwerk) wijkt mogelijk af van uw bouwnummer.



Omschrijving
Optietekening

Onderdeel	tekeningnummer		
Verkooptekening	VK-014-5		
Bouwnummer(s)	getekend	schaal	formaat
10-11,14-17,105-108	24-09-2024	1 : 100	A3

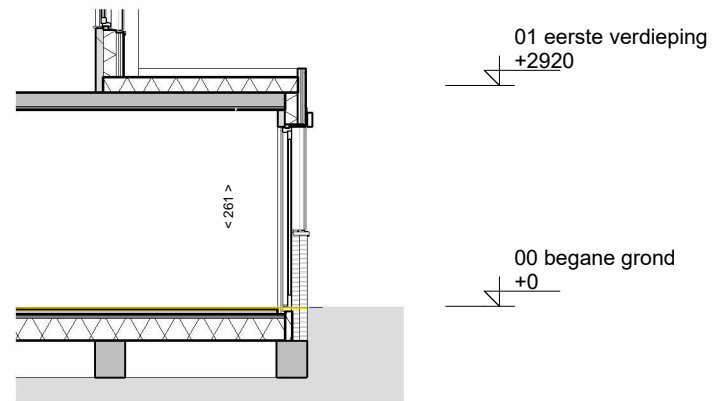

code 10145: uitbouw achtergevel 240cm

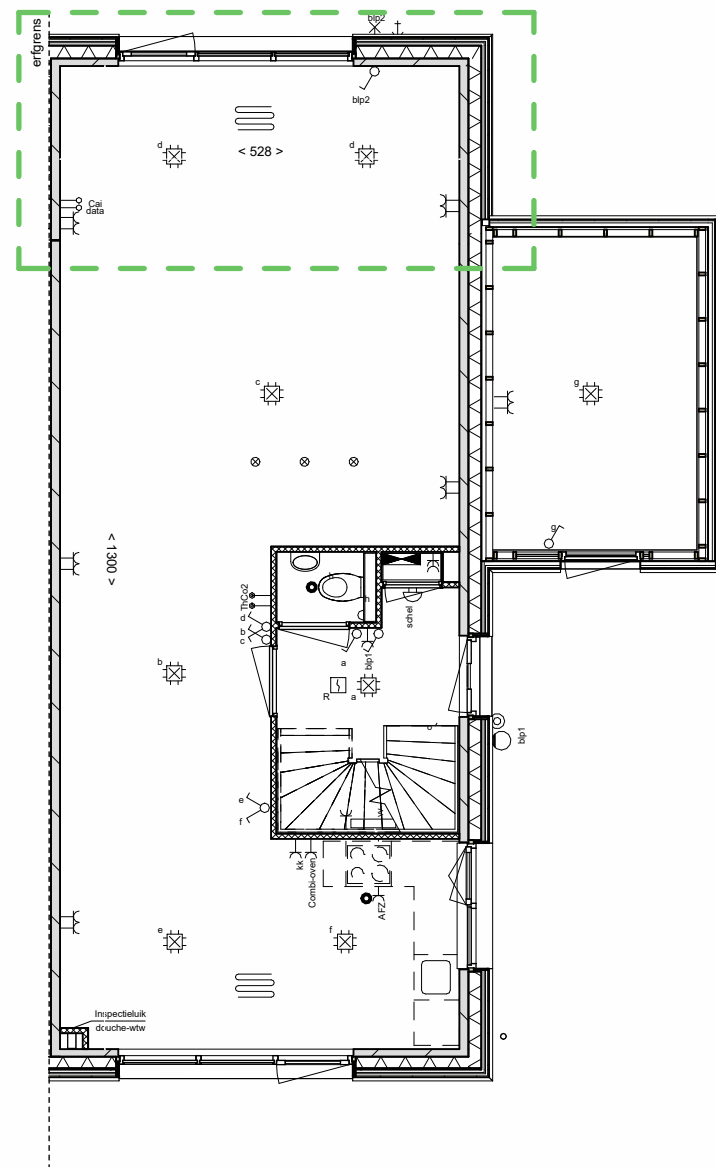

begane grond

code 10145: uitbouw achtergevel 240cm

NB:
Kopersopties slechts ter indicatie van de extra ruimte en bijbehorende gevelopeningen; materialisatie van de gevel (hout of metselwerk) wijkt mogelijk af van uw bouwnummer.

NB:
Opties onder voorbehoud goedkeuring adviseurs.

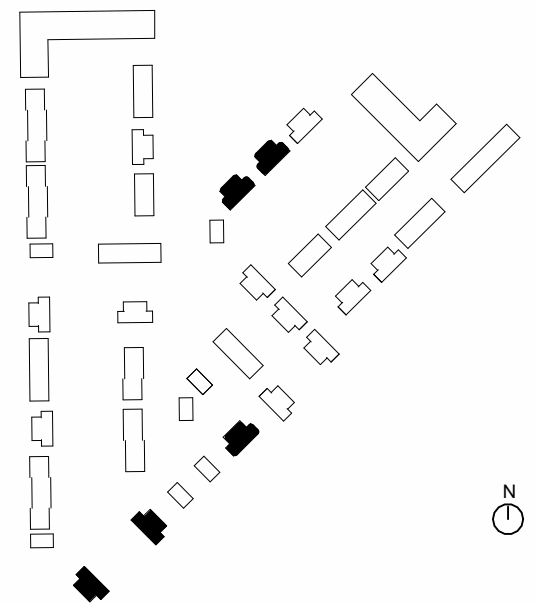

Omschrijving
Optietekeningen

Onderdeel	tekeningnummer		
Verkooptekening	VK-014-6		
Bouwnummer(s)	getekend	schaal	formaat
10-11,14-17,105-108	24-09-2024	1 : 100	A3